

SOP6900TP



Categorie	60 cm
Product familie	Oven
Stroomvoorziening	Elektrisch
Warmtebron	Elektriciteit
Bereidingswijze	Multifunctionele oven
Galileo technologie	Traditioneel pyrolyse
Reinigingssysteem	Pyrolyse reiniging
EAN-code	8017709312237



Design

Design	Victoria	Deur	Met paneel
Kleur	Crème	Handvat	Victoria
Design	Bol	Kleur handvat	Inox
Materiaal	Gelakt materiaal	Logo	Geassembleerd
Type glas	Clear1	Bedieningsknoppen	Victoria
Kleur serigrafie	Zwart	Kleur bedieningsknoppen	Inox look
Type zeefdruk	Symbolen		









Bediening

			
Display	DigiScreen	Bediening	Bedieningsknoppen
Display	LED display	Aantal bedieningsknoppen	2

Programma's / Functies

Aantal kookfuncties	9
---------------------	---

Traditionele bereidingsfuncties

 Statisch	 Statisch + ventilator	 Circulatie (ventilator + circulaire)
 Turbo: ventilator + circulaire + statisch	 ECO	 Grote grill
 Ventilator + grote grill	 Onderwarmte	 Geventileerde onderwarmte

Reinigingsfuncties

 Pyrolyse

Opties



Tijdsinstelling	Automatische in- en uitschakeling	Andere opties	Warmhoudfunctie, Eco light
Timer	Ja	Showroom demo optie	Ja
Timer	1	Snel voorverwarmen	Ja

Technische specificaties



Inhoud (l)	60 l	Circulatie - vermogen	2000 W
Cavity	QS-Galileo	Opening deur	Standaard opening
Minimum temperatuur	30 °C	Deur	Koud
Maximum temperatuur	260 °C	Uitneembare ovendeur	Ja
Aantal kookniveaus	5	Volledig glazen binnendeur	Ja
Dubbele ventilator	1	Uitneembaar glas binnendeur	Ja
Aantal lampen	2	Totaal aantal ruiten	4
Type lamp	Halogeen	Chimney	Fixed
User-replaceable light	Ja	Koelsysteem	Mantelkoeling
Vermogen lamp	40 W	Koelleiding	Dubbel
Verlichting bij opening deur	Ja	Deurblokkering tijdens pyrolyse	Ja
Onderwarmte - vermogen	1200 W	Afmetingen bruikbare interne ovenruimte (hxbxd)	353x470x401 mm
Bovenwarmte - vermogen	1000 W		
Grill - vermogen	1700 W		

Grote vlakgrill - vermogen	2700 W	Temperatuurcontrole	Elektronisch
		Materiaal ovenruimte	Ever Clean emaille

Prestaties / energielabel



Energie-efficiëntieklasse	A	Energy consumption in forced air convection	2,88 MJ
Netto volume	68 l	Energieconsumptie in turbo functie	0,80 kWh
Energieconsumptie in conventionele functie	1,09 kWh	Aantal ovens	1
Energy consumption in conventional mode	3,92 MJ	Energie-efficiëntie Index	95,2 %

Meegeleverde accessoires

Ovenrooster met stop	1	Geëmailleerde diepe ovenschaal (50 mm)	1
----------------------	---	---	---

Elektrische aansluiting

Spanning	220-240 V	Nominale aansluitwaarde	3000 W
Stekker	Nee	Frequentie	50/60 Hz
Stroom	13 A	Lengte voedingskabel	150 cm

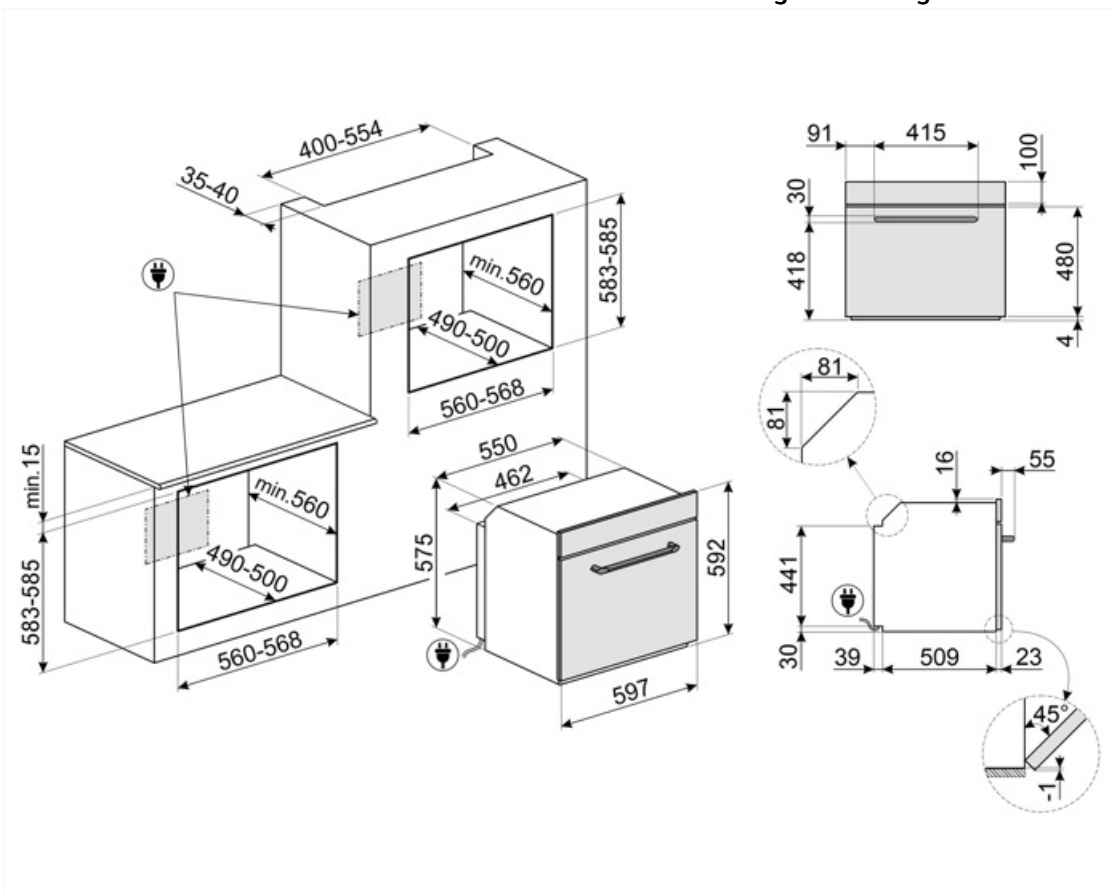

Compatible Accessories

AIRFRY



BBQ

Dubbelzijdig



ET50

Geëmailleerde ovenschaal voor 45cm en 60cm ovens. Diepte 50 mm.



GTT2

Volledig uitschuifbare telescopische rails (1 niveau) voor traditionele ovens (SO-)



PR3845X

Inox profiel voor installatie ovens in kolom



STONE2

Rectangular pizza stone without handles, suitable for 45cm and 60cm wide ovens. Dimensions W42 x H1.8 x D37.5cm. Ideal for cooking pizzas with the same results as a typical wood-fired oven. Can also be used for baking bread, focaccias and other recipes such as pies, flans or biscuits



AIRFRY2

Air fryer tray. Ideal for recreating traditional frying in the oven, but with fewer calories and less fat. It allows you to cook quickly and simply dishes such as French fries, fried vegetables and fish, ensuring perfect browning and crispiness.



ET20

Geëmailleerde ovenschaal voor 45cm en 60cm ovens. Diepte 20 mm.



GTP2

Partially extractable telescopic guides (1 level), suitable for traditional ovens. Made in stainless steel, they guarantee stability and facilitate the smooth extraction of the trays.



PALPZ

Pizzapallet inox met plooibaar handvat, 315x325 mm



STONE

Rectangular refractory stone Ideal for cooking pizzas with the same results as a typical wood-fired oven. Can also be used for baking bread, focaccias and other recipes such as pies, flans or biscuits Dimensions: L42 x H1,8 x P37,5 cm.



Alternative products



SOP6900TN















Zwart



SOP6900TX

Inox

Symbols glossary

 <p>Sommige modellen zijn voorzien van een functie om het programma/de cyclus te blokkeren zodat het niet per ongeluk kan aangepast worden.</p>	 <p>Energy efficiency class A</p>
 <p>Air cooling system: to ensure a safe surface temperatures.</p>	 <p>Quadruple glazed: Number of glazed doors.</p>
 <p>Automatic lighting deactivation: For greater energy savings, the lighting turns off automatically after one minute from the start of cooking. The option can be disabled via the settings menu. In this case the light will remain on for the entire duration of cooking.</p>	 <p>Elektrische aansluiting</p>
 <p>Ever Clean Enamel: Ever Clean enamel is applied electrostatically, corner to corner and edge to edge to prevent cracking or cracks over time. It is a particular pyrolytic enamel, resistant to acids which, in addition to being pleasantly bright, promotes greater cleaning of the oven walls, thanks to its lower porosity. It is baked at over 850 °C and slowly polymerized at a scientifically determined rate to ensure uniform depth and strength. Ever Clean enamel creates an impeccable finish both on the inside of the oven and on the trays, making the surfaces of the oven incredibly easy to maintain over time as it reduces the adhesion of fat during cooking.</p>	 <p>Fresh Touch: Most of Smeg ovens have a "cool door." Thanks to the combination of tangential cooling and internal heat-reflecting glasses, the temperature on the outer surface of the door is maintained below 50° C. In addition to providing safety, this system protects the sides of the furniture from overheating by the oven.</p>
 <p>Circogas: In gasovens verdeelt de ventilator de warmte snel en gelijkmatig over de ovenruimte, waardoor smaakoverdracht wordt vermeden bij het tegelijkertijd bereiden van een aantal verschillende gerechten. In elektrische ovens voltooit deze combinatie het koken van voedsel dat aan de oppervlakte klaar is, maar dat van binnen meer moet worden gekookt, zonder verder bruin te worden.</p>	 <p>Ventilator met bovenste en onderste elementen: De elementen in combinatie met de ventilator zijn bedoeld om een meer gelijkmatige warmte te bieden, een methode die vergelijkbaar is met conventioneel koken, dus voorverwarmen is vereist. Het meest geschikt voor items die langzaam koken vereisen.</p>
 <p>Alleen boven- en onder element: een traditionele kookmethode die het meest geschikt is voor losse items in het midden van de oven. de bovenkant van de oven zal altijd het heetst zijn. Ideaal voor gebraden vlees, fruitcake, brood etc.</p>	 <p>Base: the heat comes only from the bottom of the cavity. The fan is not active. Ideal for sweet and savory pies, cobblers and pizzas. Designed to complete cooking and make food more crunchy. This symbol in gas ovens indicates the gas burner.</p>
 <p>Circulaire: De combinatie van de ventilator en het ronde element eromheen zorgt voor een hete lucht kookmethode. Dit biedt vele voordelen, waaronder geen voorverwarmen als de kooktijd meer dan 20 minuten bedraagt, geen smaakoverdracht bij het gelijktijdig bereiden van verschillende soorten voedsel, minder energie en kortere kooktijden. Geschikt voor alle soorten voedsel.</p>	 <p>De combinatie van de grill, de ventilator en onderwarmte is interessant voor het bereiden van kleine hoeveelheden.</p>



Grill: Very intense heat coming only from above from a double heating element. The fan is not active. Provides excellent grilling and gratinating results. Used at the end of cooking, it gives a uniform browning to dishes.



Circulaire met bovenste en onderste elementen: door het gebruik van de ventilator met beide elementen kan voedsel snel en effectief worden gekookt, ideaal voor grote stukken vlees die grondig moeten worden gekookt. Het biedt een vergelijkbaar resultaat als rotisserie, waarbij de warmte rond het voedsel wordt verplaatst in plaats van het voedsel zelf te verplaatsen, waardoor elke maat of vorm kan worden gekookt.



The inner door glass: can be removed with a few quick movements for cleaning.



Side lights: Two opposing side lights increase visibility inside the oven.



Rapid preheating: cooking is preceded by the preheating phase which allows the cooking compartment to reach the set temperature. This option reduces the time by up to 50%.



Electronic control: Allows you to maintain temperature inside the oven with the precision 2-3 ° C. This enables to cook meals that are very sensitive to temperature changes, such as cakes, souffles, puddings.



The capacity indicates the amount of usable space in the oven cavity in litres.



Fan grill: very intense heat coming only from above from a double heating element. The fan is active. It allows the optimal grilling of thickest meats. Ideal for large cuts of meat.



All glass inner door: All glass inner door, a single flat surface which is simple to keep clean.



Met deze functie kan u bereidingen warmhouden zodat het eten niet meteen afkoelt



PYROLYSIS - AUTOMATIC CLEANING FUNCTION: the oven heats up to a temperature approaching 500 ° C and chars grease and food residues into a fine ash that can be easily wiped off with a damp cloth. At such a high temperature, the door locks automatically for safety, while the temperature of the door remains controlled so it is safe to touch User adjustable function based on the level of dirt present in the oven.



The oven cavity has 5 different cooking levels.



The capacity indicates the amount of usable space in the oven cavity in litres.



DIGI screen display + bedieningsknoppen